

# AI-Link

## AI-NB25

### NB-IoT Module

#### Features:

- **Support Band**  
B1/B3/B5/B8  
B2/B4/B12/B66/B71/B85
- **Chip Solution**  
MT2625DA/MT2625DP
- **Size& Dimension**  
18.7 mm x 16.0mm x 2.5mm



#### Model Overview

Model	Installation	Standard	Support Bands	Antenna
AI-NB25	SMD	3GPP Rel-13	B1/B2/B3/B4/B5/B8/B12/B66/B71/B85	External option

### Sichuan AI-Link Technology Co.,Ltd.

A Changhong Holding Group Company

Phone: +1 408-970-0349

Business via email: [jennifer.wang@changhong.us](mailto:jennifer.wang@changhong.us)

Technical via email: [jjaxin.li@changhong.com](mailto:jjaxin.li@changhong.com)

Website: <http://www.changhong.com>

**Feedback of customer's confirmation**

**Specification Available After Confirmation**

Customer name	Customer signature	Confirmation Date

Please return the form after signed, thanks!

Approved	Checked	Designed	Product	NB-IoT Module
Tom Feng	Zijin Qian	Nicky.Li	Model	AI-NB25
2019-10-10	2019-10-10	2019-10-10	Date	2019-10-10



## 1. Overview

AI-NB25 is an NB-IoT module that communicates with the infrastructure of mobile network operators through the 3GPP Rel-13 radio protocol. The core communication chip is the first NB-IoT chipset developed by MediaTek. It has embedded 2MB Flash and 2MB RAM. It integrates MCU, PMU, Flash, RAM, DSP, RF and other units, with the characteristics of high integration and low cost.

AI-NB25 module integrates RF power amplifier PA, crystal, LDO, DC-DC, reserves eSIM card, and reserves UART, ADC, SIM, RESET and GPIO interfaces to expand various applications. Some interfaces can be reused to facilitate customer secondary product development.

AI-NB25 module supports operation in bands B1, B2, B3, B4, B5, B8, B12, B66, B71 and B85. It can provide data transmission, short message and other services, and also supports the 3GPP Rel-13 standard.

AI-NB25 module is an SMD type module with size only 18.7mm x 16.0mm x 2.5mm. There are 54 pins in total. It can be embedded in various product applications through welding pad. The product size is small while its peripheral interface is rich. Compared with similar products, the advantage is obvious.

AI-NB25 module is the basic module for data wide communication in the field of Internet of Things. It can provide stable and extensive communication. The application scenario is more extensive, as long as the coverage of NB-IoT signals can support communication services.

### 1.1 Fundamental Performance

Items	Information
Voltage Input	VBAT power supply voltage range: 2.4V ~ 3.63V, typical supply voltage 3.3V
Bands	Support B1\B2\B3\B4\B5\B8\B12\B66\B71\B85
RF Power	23 ± 2dBm
Current Consumed	5uA MAX (PSM mode)
Temperature Range	-40°C ~ 85°C
SMS / Voice	Support SMS
SIM Cards	Support only 1 set external SIM card
Antenna Interface	50ohm RF impedance ( Support only 1 set external antenna)
Size	18.7mm x16.0mm x2.5mm

### 1.2 Main Functions of Product

- ◆ It supports NB-IoT B1\B2\B3\B4\B5\B8\B12\B66\B71\B85 band, provides digital transmission services, and supports 3GPP Rel-13 standard
- ◆ Supports only 1 set external SIM card
- ◆ Supports 3 groups UARTs
- ◆ Supports 1 set SPI , I2C of chip
- ◆ GPIO supports 27sets of GPIOs
- ◆ Supports 1 set of ADC interfaces
- ◆ NB-IoT power supply 3.3V (standard value)
- ◆ Radio frequency antenna interface, 50 ohm standard interface

## 2. Application Interface

The AI-NB25 module has 54 patch pins. The following sections briefly describe the functions of each pin interface of the module.

### 2.1 Pin Distribution

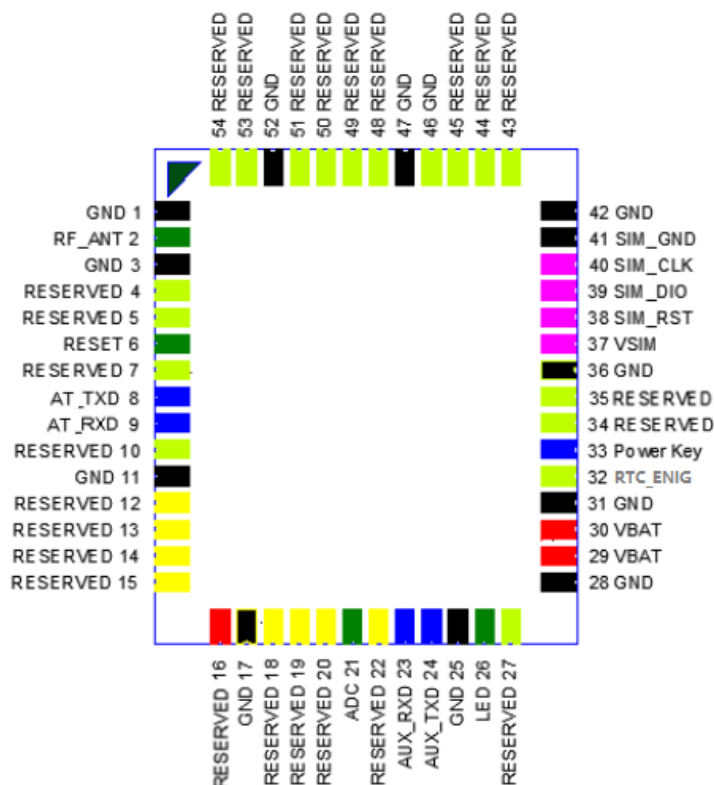

Fig. 1 Diagram of pin distribution

## 2.2 Pin Definition

Pin No	Pin Name	Type	Description	Comments
1	GND	/	Ground	
2	RF_ANT	I/O	Module antenna interface, RF output 50 ohm characteristic impedance	
3	GND	/	Ground	
4	RESERVED	DIO	Reserved GPIO0	
5	RESERVED	DIO	Reserved GPIO1	
6	RESET	I	Module reset pin, active low, staging time greater than 100ms	
7	RESERVED	DIO	Reserved GPIO3	
8	AT_TXD	O	Major serial port, sending data, used for AT command and data TX transmission	
9	AT_RXD	I	Major serial port, receive data, used for AT command and data RX transmission	
10	RESERVED	DIO	Reserved GPIO8	
11	GND	/	Ground	
12	RESERVED	DIO	Reserved GPIO7	
13	RESERVED	DIO	Reserved GPIO6	
14	RESERVED	DIO	Reserved GPIO9	
15	RESERVED	DIO	Reserved GPIO10	
16	RESERVED	DIO	Reserved GPIO12	
17	GND	/	Ground	
18	RESERVED	DIO	Reserved GPIO14	
19	RESERVED	DIO	Reserved GPIO15	
20	RESERVED	DIO	Reserved GPIO13	
21	ADC	DIO	Reserved GPIO30	
22	RESERVED	DIO	Reserved GPIO36	
23	AUX_RXD	I	Auxiliary serial port, receive data	
24	AUX_TXD	O	Auxiliary serial port, sending data	
25	GND	/	Ground	
26	LED	DIO	Network indicator LED, GPIO26	
27	RESERVED	DIO	Reserved GPIO18	
28	GND	/	Ground	
29	VBAT	I	Module power supply, 2.4V ~ 3.63V, Typical voltage 3.3V	
30	VBAT	I	Module power supply, 2.4V ~ 3.63V, Typical voltage 3.3V	
31	GND	/	Ground	
32	RTC_ENIG	I	Extended RTC Interrupt for PSM mode	
33	Power Key	I	Module boot power Key, drop-down effective	
34	RESERVED	AIO	Reserved USB interface (USB_DP+)	

35	RESERVED	AIO	Reserved USB interface (USB_DM+)	
36	GND	/	Ground	
37	VSIM	O	Power supply voltage for external SIM card	
38	SIM_RST	O	Reset external SIM card	
39	SIM_DIO	I/O	External SIM card data	
40	SIM_CLK	O	External SIM card clock	
41	SIM_GND	/	Ground for External SIM card	
42	GND	/	Ground	
43	RESERVED	DIO	Reserved GPIO4	
44	RESERVED	DIO	Reserved GPIO27	
45	RESERVED	I	Reserved for USB power supply	
46	GND	/	Ground	
47	GND	/	Ground	
48	RESERVED	DIO	Reserved GPIO28	
49	RESERVED	DIO	Reserved GPIO29	
50	RESERVED	DIO	Reserved GPIO34	
51	RESERVED	DIO	Reserved GPIO33	
52	GND	/	Ground	
53	RESERVED	DIO	Reserved GPIO32	
54	RESERVED	DIO	Reserved GPIO20	

### 3. Antenna Interface

The pin 2 is the RF antenna pad. The RF interface has an impedance of 50Ω.

#### 3.1 Pin Definition of the RF\_ANT

Pin Definition of the RF\_ANT table

Name	Pin	Description
GND	1	Ground
RF_ANT	2	RF antenna pad
GND	3	Ground

#### 3.2 RF Reference Design

A reference design of RF is shown as below

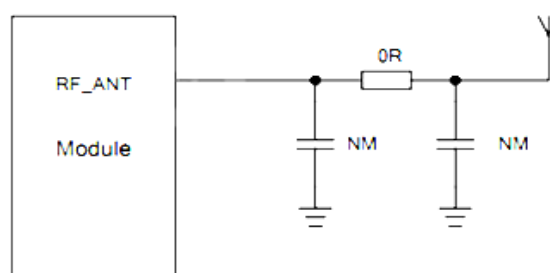

### 3.3 RF Reference Design

The RF trace in host PCB connected to the module RF antenna pad should be coplanar waveguide line microstrip line, whose characteristic impedance should be set to  $50\ \Omega$ . It is recommended to use coplanar waveguide line. The characteristic impedance of coplanar waveguide line could be affected by many factors, such as dielectric constant, distance between signal layer and reference ground(H), line width(W), clearance between line and ground(S), copper foil thicknesses(T). The relative relationship between those parameters could be obtained through software like CITS25, shown as follows.

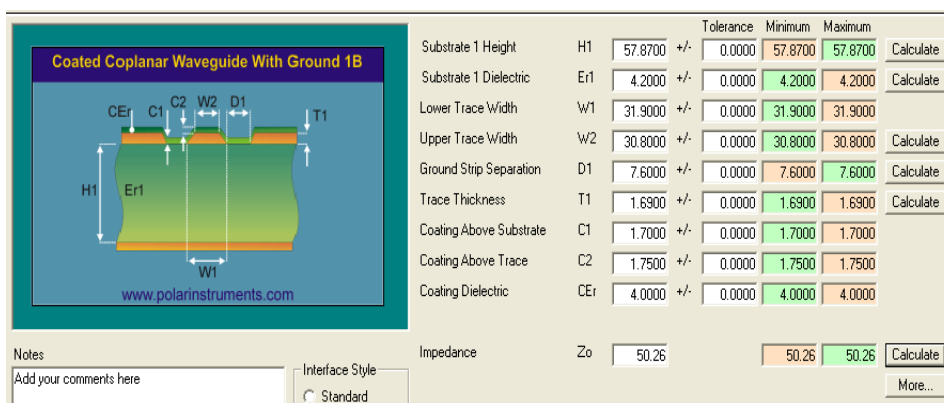

Fig. 2 Coplanar Waveguide Line Structure (Software Calculation)

The reference ground would be different for different host PCB. It should set the top layer as RF trace and set layer2 or bottom layer as reference ground for four-layer or two-layer PCB, as shown in following figure.

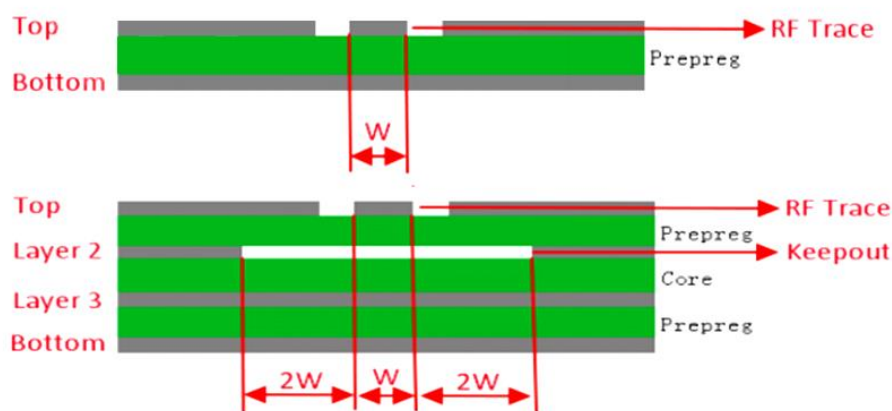

Fig. 3 PCB stack recommend



### 3.4 Antenna Reference Design

AI-NB25 module provides an RF antenna (pin2) pad for antenna connection. There are two grounding pads (pin1 & pin3) on both sides of the antenna pad in order to give a better grounding. Besides,  $\pi$ -type match circuit is suggested to be used to adjust the balance of antenna RF performance, and it is better to keep match circuit close to RF\_ANT port of the module.

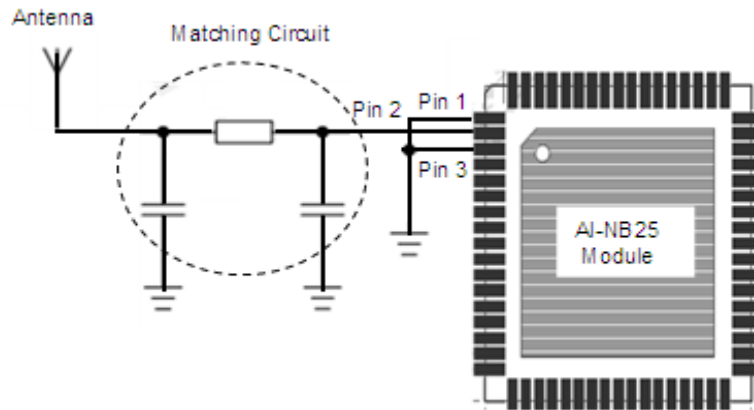

Fig. 4 Antenna matching circuit diagram

### 3.5 Antenna Design Indicators

#### Antenna Efficiency :

Antenna efficiency is the ratio of the input power to the radiated or received power of an antenna. The radiated power of an antenna is always lower than the input power due to the following antenna losses: return loss, material loss, and coupling loss. The efficiency of an antenna relates to its electrical dimensions. The following antenna efficiency (free space) is recommended for AI-NB25 module to ensure high radio performance of the module:

Efficiency of the antenna  $\geq 40\%$  (below 960 MHz);  $\geq 50\%$  (over 1710 MHz)

#### S11 (VSWR) :

S11 indicates the degree to which the input impedance of an antenna matches the reference impedance ( $50 \Omega$ ). S11 shows the resonance feature and impedance bandwidth of an antenna.

Voltage standing wave ratio (VSWR) is another expression of S11. S11 is less important than the efficiency, and S11 has weak correlation to wireless performance.

The following S11 value is recommended for the antenna of AI-NB25 module:

S11 of the primary antenna  $\leq -6$  dB

### Isolation

For a wireless device with multiple antennas, the power of different antennas is coupled with each other. Antenna isolation is used to measure the power coupling. The power radiated by an antenna might be received by an adjacent antenna, which decreases the antenna radiation efficiency and affects the running of other devices. To avoid this problem, evaluate the antenna isolation as sufficiently as possible at the early stage of antenna design.

Isolation recommended between the primary antenna and the other antenna  $\geq 15$  dB

### Polarization

The polarization of an antenna is the orientation of the electric field vector that rotates with time in the direction of maximum radiation. The linear polarization is recommended for the antenna of AI-NB25 module.

### Gain and Directivity

The radiation pattern of an antenna represents the field strength of the radiation.

Gain, as another important parameter of antennas, correlates closely to the directivity.

The gain of an antenna takes both the directivity and the efficiency of the antenna into account.

Gain of the primary/diversity antenna recommended for module  $\leq 2.5$  dBi

## 4. Operating Mode

The AI-NB25 module integrates baseband, RF and other units. The following sections briefly describe each function.

### 4.1 Boot up with module

When the VBAT power supply input reaches the minimum operating voltage, the external RESET input keeps high level, and the module will turn on automatically.

### 4.2 Shut down with module

When the VBAT power supply is disconnected, the module will be turned off.

### 4.3 Voltage DC supply

The input of the module's power supply uses DC voltage source, and it needs to meet the instantaneous peak current of 0.5A at the time of transmitting pulse. The voltage drop, noise and interference in input voltage will directly affect the performance of the module. To eliminate these interference, low ESR 100uF tantalum capacitors, 100nF, 100pF and 33pF combinations are recommended. Filter capacitor should be as close as possible to the module. The use of voltage regulator and TVS tube is recommended for module power supply entrance.

### 4.4 Voltage Output

The power management unit of the module provides digital stable power output and provides power for peripheral low-power devices. The output voltage and the maximum current of the pin are as follows.

Pin No	Pin Name	Description	Voltage Output	Max Current
37	VSIM	SIM Power	1.8V /3.0V	150mA

### 4.5 Serial Port

The module contains two sets of serial interfaces for AT command transceiver, data transmission, firmware upgrade and debugging. The major serial port can be used for AT command communication and data transmission. The baud rate is 115 200 bps. It can also burn and upgrade firmware through Flash tool. The baud rate of firmware upgrade is 115 200 bps.

### 4.6 Operating Status

Active: Modules are active, all functions are available and data can be sent and received,

Modules can switch to Idle mode or PSM mode in this mode.

Idle: The module is in a shallow sleep state, the network remains connected and can receive paging messages; in this mode, the module can switch to Active mode or PSM mode.

PSM: The module only works with RTC and is in the non-connected state of the network. It no longer receives paging messages, however, the module needs to wake up after RTC or external interruption.

### 4.7 PSM mode (Power Saving Mode)

The maximum current consumption of modules under PSM is less than 5uA. The main purpose of PSM is to reduce module power consumption and extend battery power supply time. The following figure shows the power consumption of modules in different modes.

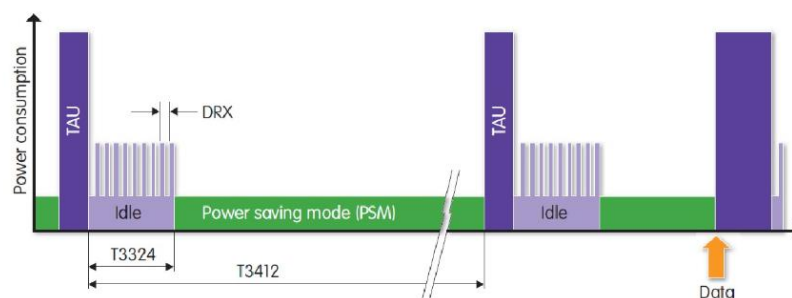

Fig. 5 power consumption diagram

## 5. Electrical Characteristics

### 5.1 Voltage Supply

VBAT power supply must be specified, otherwise the module could be shut down, damaged and so on

Pin	Pin name	Min	Typical	Max	Unit
29	VBAT	2.4	3.3	3.63	V
30	VBAT	2.4	3.3	3.63	V

### 5.2 Current Supply

Item	Min	Typical	Max	Unit	Condition
PSM mode	/	/	5	uA	Sleep
Idle mode	/	1	/	mA	idle@2.56S
Active TX	/	330	/	mA	TX 23dBm
Active RX	/	15	/	mA	RX

### 5.3 Environmental Conditions

The ambient temperature of the module must be within the specified range, otherwise it will not guarantee stable performance and normal operation.

Temperature range	Min	Typical	Max	Unit
Operating temp	-40	25	85	°C
Storage temp	-40	25	125	°C

## 6. Radio Characteristics

### 6.1 Test Environmental and Diagram

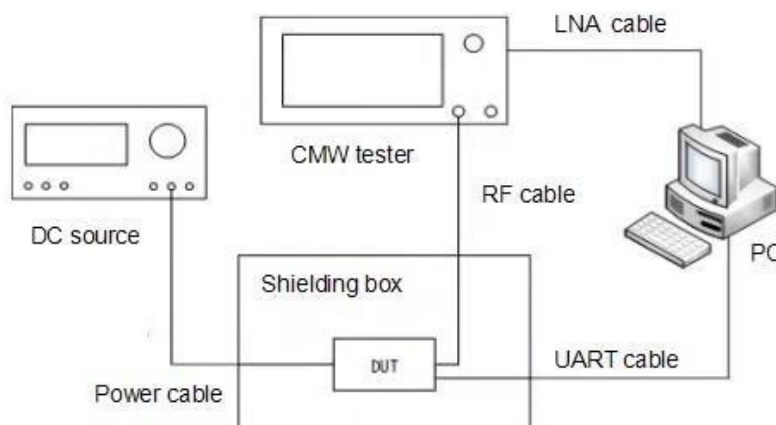

Fig. 6 Test structure diagram

## 6.2 NB-IoT Radio Characteristics

### Frequency characteristics

Support Bands	Rx frequency	Tx frequency
B1	2110-2170 MHz	1920-1980 MHz
B2	1930-1990 MHz	1850-1910 MHz
B3	1805-1880 MHz	1710-1785 MHz
B4	2110-2155MHz	1710-1785 MHz
B5	869-894 MHz	824-849 MHz
B8	925-960 MHz	880-915 MHz
B12	729-746 MHz	699 -716MHz
B66	2110-2180 MHz	1710-1780MHz
B71	617-652 MHz	663-698 MHz
B85	728-746 MHz	698-716 MHz

### TX power

Support Bands	Tx power	Offset
B1	23	$\pm 2$
B2	23	$\pm 2$
B3	23	$\pm 2$
B4	23	$\pm 2$
B5	23	$\pm 2$
B8	23	$\pm 2$
B12	23	$\pm 2$
B66	23	$\pm 2$
B71	23	$\pm 2$
B85	23	$\pm 2$

### Sensitivity

Support Bands	Sensitivity	Unit
B1	-113	dBm
B2	-113	dBm
B3	-113	dBm
B4	-113	dBm
B5	-113	dBm
B8	-113	dBm
B12	-113	dBm
B66	-113	dBm
B71	-113	dBm
B85	-113	dBm

## 7. Mechanical Properties

### 7.1 Mechanical dimension drawing

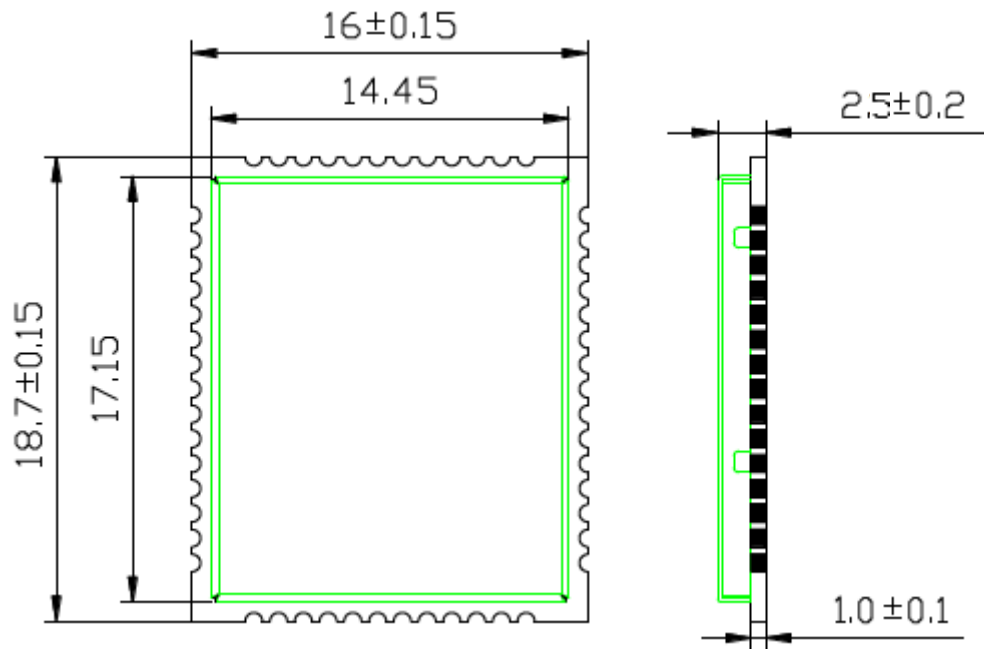

Fig. 7 Top view (unit: mm)

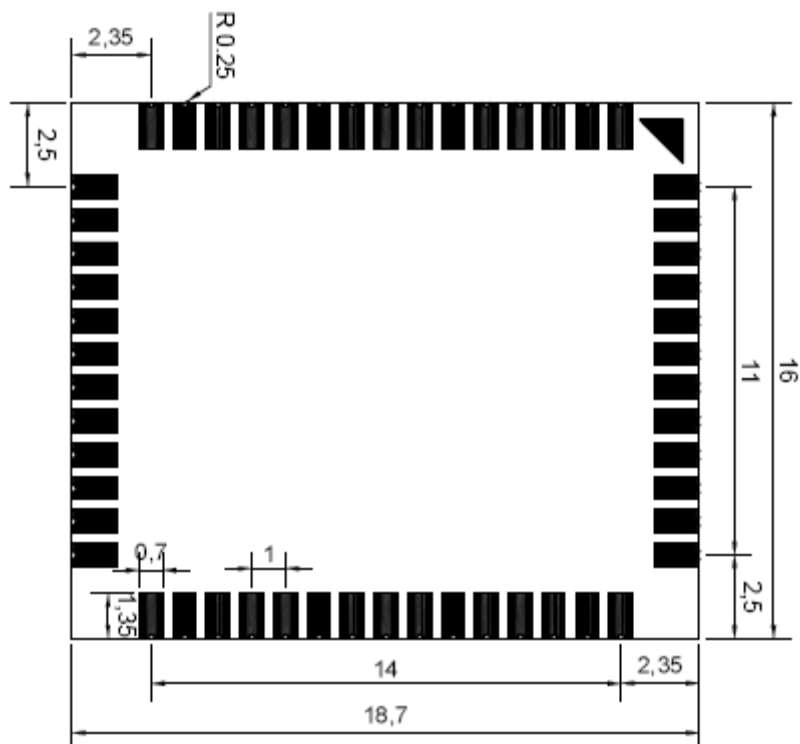

Fig. 8 Bottom view (unit: mm)

7.2 Footprint recommended

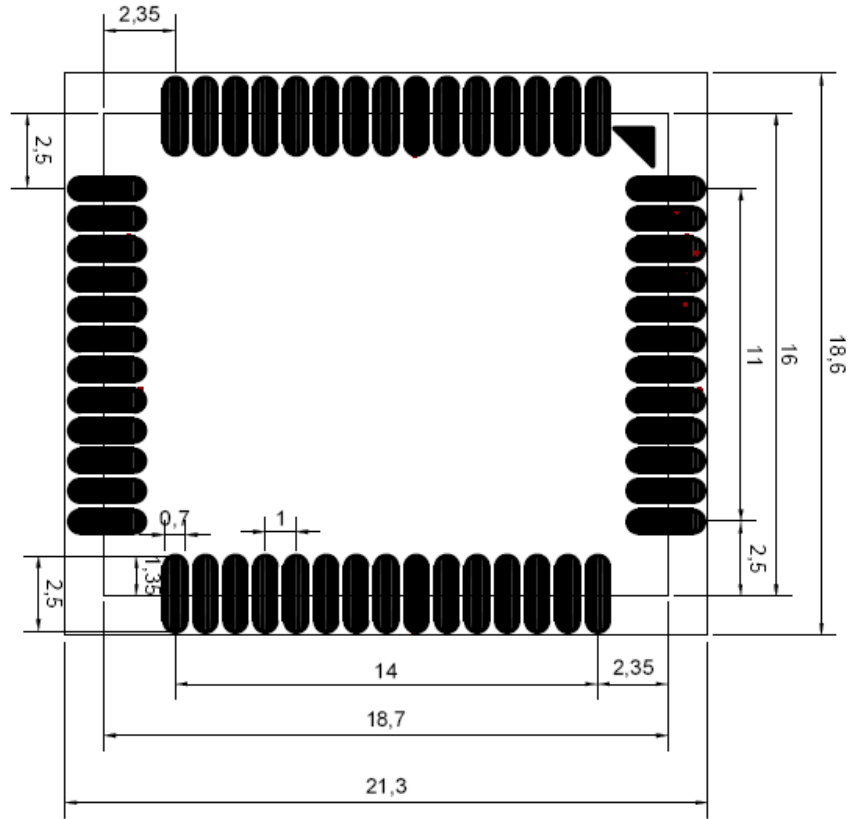

Fig. 9 Dimension (unit: mm)

7.3 Product Picture View



Fig. 10 Top view

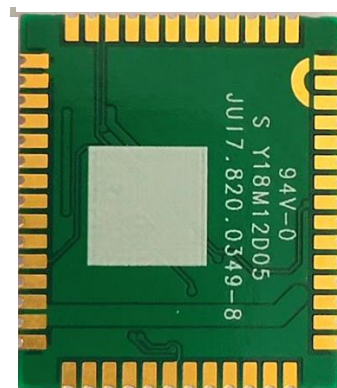
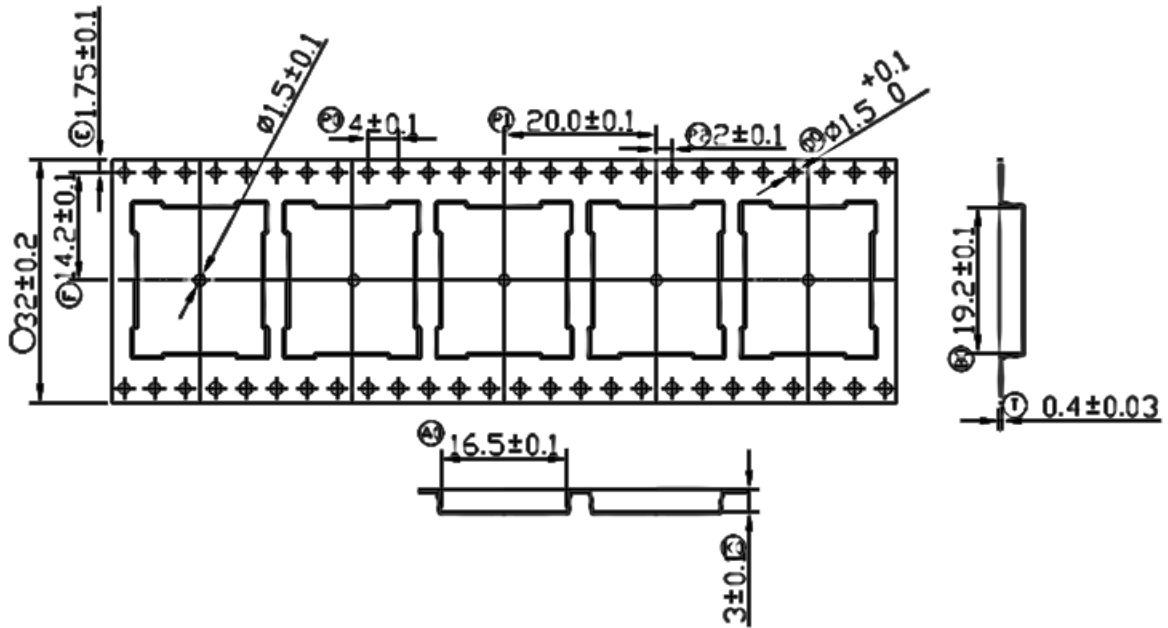

Fig. 11 Bottom view

### 8. Reel Packing Template



#### 8.1 Reel direction

Packing Direction

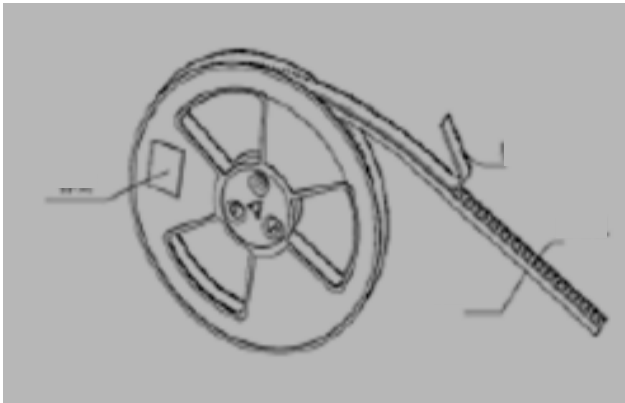

#### 8.2 Packing diagram







### 8.3: Label template

Module QA

Model: AI-NB25 (RoHS)

Qty: XXX

Number: 

Inner Box label

Module QA

Model: AI-NB25 (RoHS)

Qty: XXXX

Weight: XX / . Kg

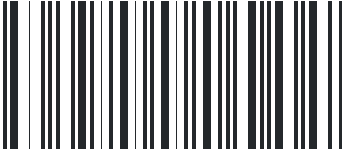
Box No: 

2 0 0 0 0 1

Outer Box label

## 9. Soldering Reflow Recommendation

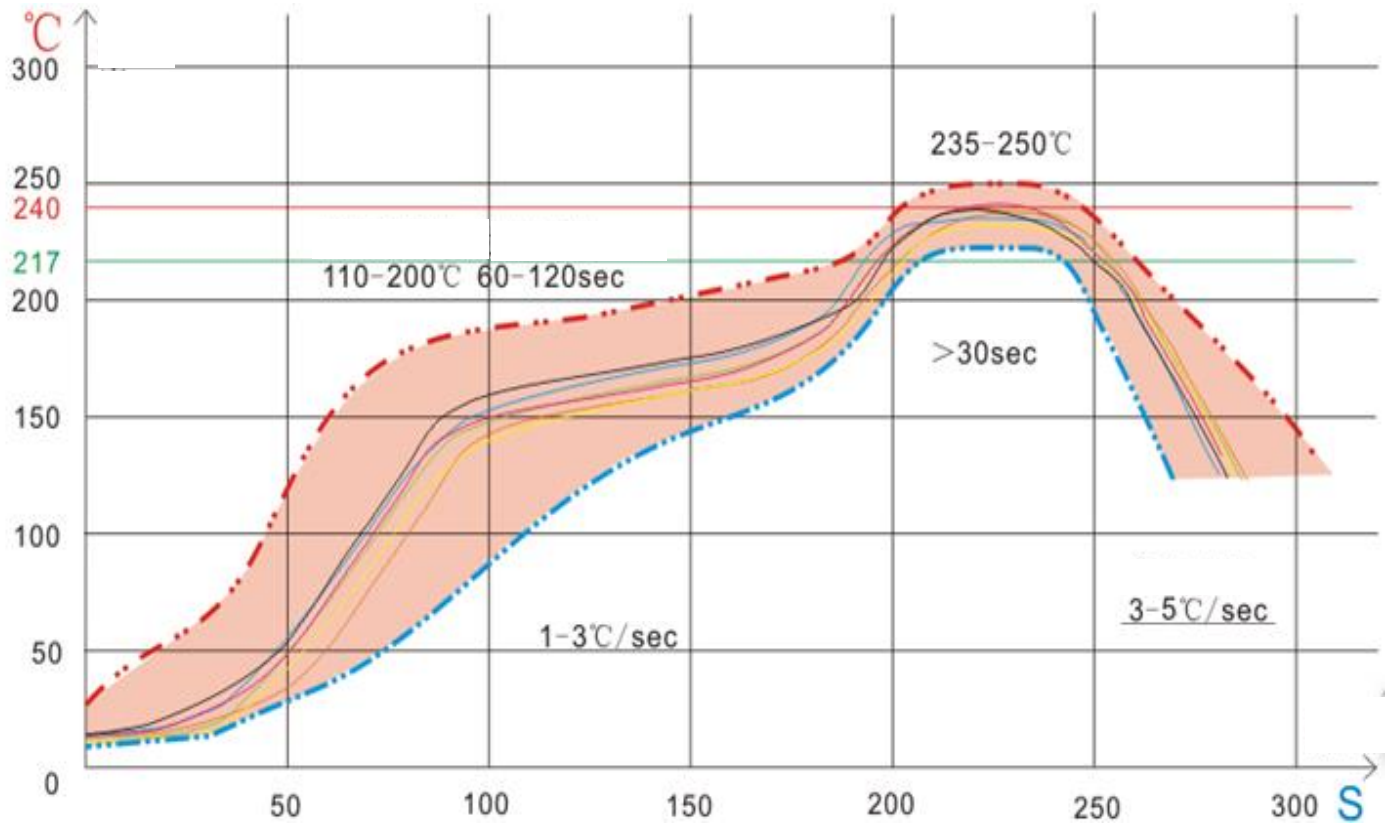

Heating zone: temperature: <150 C, time 60~90 seconds, the slope is controlled at 1~3 C/S.

Preheating constant temperature zone: temperature: 150 ~ 200 C, time: 60-120 seconds, the slope is between 0.3~0.8 C/S.

Reflow soldering area: the peak temperature is 235 C ~250 C (recommended peak temperature is less than 245 C), and the time is 30-70 seconds.

Cooling zone: temperature: 217 C ~170 C, slope at 3~5 C/S.

The solder is tin silver copper alloy lead-free solder / Sn&Ag&Cu lead-free solder (SAC305).

Note: The product can withstand the limit temperature of 255 degrees and 5 seconds. In order to ensure the product quality, the reflow curve should seek a balance between PCB and components without damaging the quality of solder joints, and should be carried out within the above curve range.

## 10. FCC Certification Announcement

According to the definition of mobile and fixed device as described in Part 2.1091(b), this device is a mobile device.

And the following conditions must be met:

1. This Modular Approval is limited to OEM installation for mobile and fixed applications only.  
The antenna installation and operating configurations of this transmitter, including any applicable source-based time- averaging duty factor, antenna gain and cable loss must satisfy MPE categorical Exclusion Requirements of 2.1091.
2. The EUT is a module; maintain at least a 20 cm separation between the EUT and the user's body.  
And must not transmit simultaneously with any other antenna or transmitter.
3. A label with the following statements must be attached to the host end product:  
This device contains FCC ID: 2AOKI-AI-NB25.
4. To comply with FCC regulations limiting both maximum RF output power and human exposure to RF radiation, maximum antenna gain (including cable loss) must not exceed:  
LTE(NB-IOT) B2/B4/B12/B66/B71 <0.95dBi
5. This module must not transmit simultaneously with any other antenna or transmitter.
6. The host end product must include a user manual that clearly defines operating requirements and conditions that must be observed to ensure compliance with current FCC RF exposure guidelines.

For portable devices, in addition to the conditions 3 through 6 described above, a separate approval is required to satisfy the SAR requirements of FCC Part 2.1093.

If the device is used for other equipment, separate approval is required for all other operating configurations, including portable configurations with respect to 2.1093 and different antenna configurations.

For this device, OEM integrators must be provided with labeling instructions of finished products. Please refer to Product Picture View FCC ID, Page 15/20 last two paragraphs:

A certified module has the option to use a permanently affixed label, or an electronic label. For a permanently affixed label, the module must be labelled with an FCC ID - (see 2.2 Page 15/20 above). The OEM manual must provide clear instructions explaining to the OEM the labelling requirements, options and OEM user manual instructions that are required (see next paragraph).

For a host using a certified module with a standard fixed label, if (1) the module'ss FCC ID is not visible when installed in the host, or (2) if the host is marketed so that end users do not have straight forward commonly used methods for access to remove the module so that the FCC ID of the module is visible; then an additional permanent label referring to the enclosed module: "Contains Transmitter Module FCC ID:2AOKI-AI-NB25" or "Contains FCC ID: 2AOKI-AI-NB25" must be used. The host OEM user manual must also contain clear instructions on how end users can find and/or access the module and the FCC ID.

The final host / module combination may also need to be evaluated against the FCC Part 15B criteria for unintentional radiators in order to be properly authorized for operation as a Part 15 digital device.

The user's manual or instruction manual for an intentional or unintentional radiator shall caution the user that changes or modifications not expressly approved by the party responsible for compliance could void the user's authority to operate the equipment. In cases where the manual is provided only in a form other than paper, such as on a computer disk or over the Internet, the information required by this section may be included in the manual in that alternative form, provided the user can reasonably be expected to have the capability to access information in that form.

This device complies with part 15 of the FCC Rules. Operation is subject to the following two conditions: (1) This device may not cause harmful interference, and (2) this device must accept any interference received, including interference that may cause undesired operation.

Changes or modifications not expressly approved by the manufacturer could void the user's authority to operate the equipment.

To ensure compliance with all non-transmitter functions the host manufacturer is responsible for ensuring compliance with the module(s) installed and fully operational. For example, if a host was previously authorized as an unintentional radiator under the Declaration of Conformity procedure without a transmitter certified module and a module is added, the host manufacturer is responsible for ensuring that after the module is installed and operational the host continues to be compliant with the Part 15B unintentional radiator requirements.